

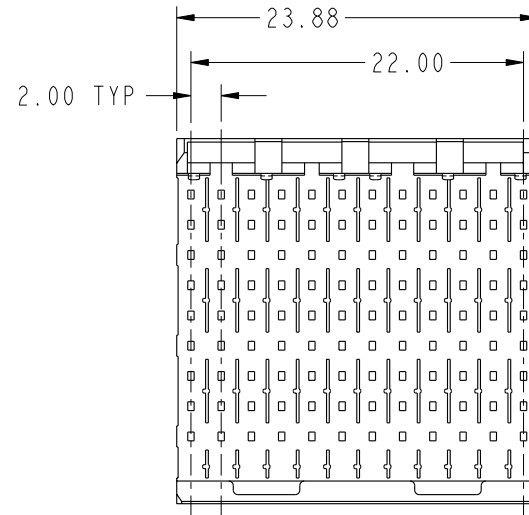

This document is the property of and embodies  
 CONFIDENTIAL and PROPRIETARY information of FCI.  
 No part of the information shown on this  
 document may be used in any way or disclosed  
 to others without the written consent of FCI.  
 Copyright FCI.

| PRODUCT NUMBER | PLATING PERFORMANCE LEVEL | PRESS FIT TAIL PLATING |
|----------------|---------------------------|------------------------|
| 74993-102      | TELCORDIA CO              | STANDARD               |
| 74993-102LF    |                           | LEAD FREE              |
| 74993-502      | TELCORDIA UE              | STANDARD               |
| 74993-502LF    |                           | LEAD FREE              |

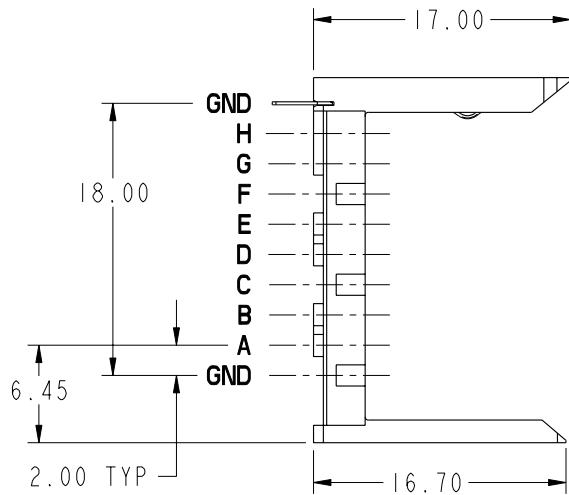
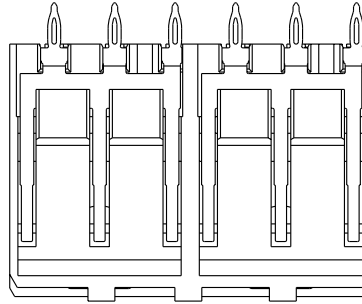

|                       |                |      |            |                                       |                        |                                 |                                                                |        |
|-----------------------|----------------|------|------------|---------------------------------------|------------------------|---------------------------------|----------------------------------------------------------------|--------|
| mat'l code SEE NOTE 5 |                |      |            | tolerances unless otherwise specified |                        | CUSTOMER                        | FCI<br>www.fciconnect.com                                      |        |
| ltr                   | ecn no.        | dr   | date       | linear                                | 0.X ±0.3               | COPY                            | title<br>VERTICAL SIGNAL HDR SHROUD<br>8 ROW P.F. 96 POS. EXT. |        |
| A                     | V90180         | L-IV | 1999-04-13 |                                       | 0.XX ±0.13             | projection                      |                                                                |        |
| B                     | V94091         | MRS  | 1999-11-10 |                                       | .XXX ±.051             |                                 |                                                                |        |
| C                     | V12223         | EPK  | 2001-09-17 | angles                                | 0° ±2°                 | product family METRAL 1000 code |                                                                |        |
| D                     | V05-0797       | VS   | 2005-08-31 | dr                                    | E. KROPER. 2001-09-17  | MM                              | size                                                           | 213    |
| E                     | V06-0644       | DCH  | 2006-06-12 | engr                                  | J. VOLSTORF 2001-09-17 | scale<br>2:1                    | dwg no                                                         | 1 of 3 |
| F                     | V07-0180       | DCH  | 2007-04-18 | chr                                   | J. VOLSTORF 2001-09-17 |                                 | A                                                              | 74993  |
| G                     | V08-0046       | HTB  | 2008-01-30 | appd                                  | J. VOLSTORF 2001-09-17 |                                 |                                                                |        |
| sheet index           | revision sheet | G 1  | G 2        | G 3                                   |                        |                                 |                                                                |        |

PRODUCT NUMBER  
SEE SHEET 1

|                                |                                        |                               |
|--------------------------------|----------------------------------------|-------------------------------|
| PRESS-FIT HOLES                | OPTION 1<br>ROWS GND-PIN,<br>A,B,C,D,E | OPTION 2<br>ROW<br>GND-SPRING |
| HOLE DIAMETER<br>AFTER PLATING | 0.65-0.80                              | 0.45-0.55                     |
| DRILLED HOLE                   | 0.81-0.86<br>(0.85 DRILL)              | 0.60±0.02                     |
| COPPER PLATING                 | 0.025 MIN                              | 0.025 MIN                     |
| SnPb PLATING                   | 0.005-0.015                            | 0.005-0.015                   |

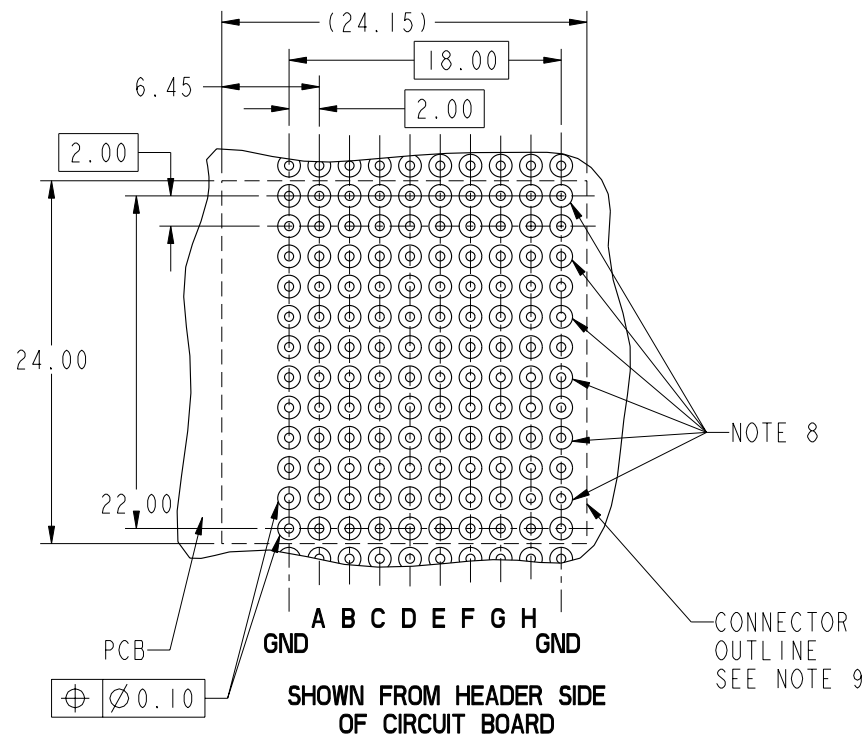

This document is the property of and embodies  
 CONFIDENTIAL and PROPRIETARY information of FCI.  
 No part of the information shown on this  
 document may be used in any way or disclosed  
 to others without the written consent of FCI.  
 Copyright FCI.

|                          |                |    |      |                                          |                        |            |                                                       |             |       |       |
|--------------------------|----------------|----|------|------------------------------------------|------------------------|------------|-------------------------------------------------------|-------------|-------|-------|
| mat'l code<br>SEE NOTE 5 |                |    |      | tolerances unless<br>otherwise specified |                        | CUSTOMER   | FCI<br>www.fciconnect.com                             |             |       |       |
| ltr                      | ecm no.        | dr | date | linear                                   | 0.X ±0.3               | COPY       | title                                                 |             |       |       |
| G                        |                |    |      |                                          | 0.XX ±0.13             | projection | VERTICAL SIGNAL HDR SHROUD<br>8 ROW P.F. 96 POS. EXT. |             |       |       |
|                          |                |    |      | angles                                   | .XXX ±.051             |            | product family                                        |             |       |       |
|                          |                |    |      |                                          | 0° ±2°                 |            | MM                                                    | METRAL 1000 | code  |       |
|                          |                |    |      | dr                                       | E. KROPER. 2001-09-17  |            | size                                                  | dwg no      | 213   |       |
|                          |                |    |      | engr                                     | J. VOLSTORF 2001-09-17 |            | 2:1                                                   | A           | 74993 | sheet |
|                          |                |    |      | chr                                      | J. VOLSTORF 2001-09-17 |            |                                                       |             |       | 2     |
|                          |                |    |      | appd                                     | J. VOLSTORF 2001-09-17 |            |                                                       |             |       |       |
| sheet index              | revision sheet |    |      |                                          |                        |            |                                                       | cage code   | 22526 |       |



PRODUCT NUMBER  
SEE SHEET 1

NOTES:

1. SEE APPLICATION SPECIFICATION GS-20-010 FOR INFORMATION ON AVAILABLE TOOLING, CIRCUIT BOARD DESIGN CONSIDERATIONS, REPAIR PROCEDURES AND PRODUCT OFFERINGS.
2. SEE FCI PUBLICATION 950511-028 FOR "ELECTRICAL PERFORMANCE DATA FOR DIFFERENTIAL APPLICATIONS."
3. SEE FCI PUBLICATION 950511-029 FOR "ELECTRICAL PERFORMANCE DATA FOR SINGLE-ENDED APPLICATION."
4. UNLESS OTHERWISE SPECIFIED, ALL DIMENSIONS AND TOLERANCES ARE IN ACCORDANCE WITH ASME Y14.5, 1994
5. HOUSING MATERIAL: LIQUID CRYSTAL POLYMER, 30% GLASS FILLED, FLAMERETARDANT PER UL 94-V0. GROUND SPRING MATERIAL: PHOSPHER BRONZE STRIPLINE SHIELDED MATERIAL: PHOSPHER BRONZE
6. PLATING INFORMATION: PLATING IN CONTACT AREA MEETS THE PERFORMANCE LEVEL SHOWN IN TABLE ON SHEET 1. PLATING ON "LF" TAILS IS Sn ONLY; PLATING ON ALL OTHER TAILS IS SnPb.
7. THE MIN PCB THICKNESS FOR REAR PLUG-UP APPLICATIONS IS 2.9mm SINCE THE COMPLIANT SECTIONS OF THE GROUND SPRING OF THE HEADER DIRECTLY OPPOSE THE GROUND SPRING OF THE SHROUD.
8. THESE HOLES ARE NEEDED FOR REAR PLUG-UP DESIGNS USING A SHROUD. ALL OTHER HOLES ARE FOR THE HEADER.
9. THE 'SHROUD OUTLINE' IS THE MIN OUTLINE REQUIRED. TO DETERMINE THE OUTLINE NECESSARY TO PERMIT THE VARIOUS TYPES OF REPAIR OPERATIONS, SEE APPLICATION SPECIFICATION GS-20-010.
10. CURRENT RATING: 1 AMP PER PIN
11. TEMPERATURE RANGE: -55°C TO +105°C
12. PRODUCTS WHERE THE PART NUMBERS ENDS IN LF MEET EUROPEAN UNION DIRECTIVES AND OTHER COUNTRY REGULATIONS AS DESCRIBED IN GS-22-008. FOR LEAD FREE PART NUMBERS, ADD 'LF' SUFFIX EXAMPLE: 74993-X02LF
13. ALL PRODUCTS WILL WITHSTAND EXPOSURE TO 260°C FOR 60 SECONDS IN A CONVECTION, INFRA-RED OR VAPOR PHASE REFLOW OVEN.

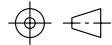

This document is the property of and embodies CONFIDENTIAL and PROPRIETARY information of FCI. No part of the information shown on this document may be used in any way or disclosed to others without the written consent of FCI. Copyright FCI.

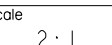
|                          |                |    |      |                                       |             |            |                                                                                       |  |                                                                                                          |  |
|--------------------------|----------------|----|------|---------------------------------------|-------------|------------|---------------------------------------------------------------------------------------|--|----------------------------------------------------------------------------------------------------------|--|
| mat'l code<br>SEE NOTE 5 |                |    |      | tolerances unless otherwise specified |             |            | CUSTOMER                                                                              |  |  www.fciconnect.com |  |
| ltr                      | ecn no.        | dr | date | linear                                | 0.X ±0.3    |            | COPY                                                                                  |  | title<br>VERTICAL SIGNAL HDR SHROUD<br>8 ROW P.F. 96 POS. EXT.                                           |  |
| G                        |                |    |      |                                       | 0.XX ±0.13  |            | projection                                                                            |  |                                                                                                          |  |
|                          |                |    |      |                                       | .XXX ±.051  |            |  |  |                                                                                                          |  |
|                          |                |    |      | angles                                | 0° ±2°      |            |  |  | product family METRAL 1000 code<br>size dwg no 74993 sheet<br>3                                          |  |
|                          |                |    |      | dr                                    | E. KROPER.  | 2001-09-17 | MM                                                                                    |  |                                                                                                          |  |
|                          |                |    |      | enr                                   | J. VOLSTORF | 2001-09-17 |  |  |                                                                                                          |  |
|                          |                |    |      | chr                                   | J. VOLSTORF | 2001-09-17 | scale                                                                                 |  |                                                                                                          |  |
|                          |                |    |      | appd                                  | J. VOLSTORF | 2001-09-17 | 2:1                                                                                   |  |                                                                                                          |  |
| sheet index              | revision sheet |    |      |                                       |             |            |                                                                                       |  |                                                                                                          |  |